

D5Y/D5W SERIES

This model is upgraded from D5Y, D5W

■ Features

- Various input specification
: STATIC input, DYNAMIC input, 4/5 BIT SERIAL input,
16/20/25 BIT SERIAL Input type
- Decimal point, "-" symbol display type selection function
: Display type and external DP by SERIAL input
Display type by terminal and Minus terminal
- Positive / Negative logic input selection function
- Display digit selection function
: 4Digit (-9999~9999), 5Digit (0~99999)
- Zero Blank function selection function
- Selectable reversion function of latch signal



⚠ Please read "Caution for your safety" in operation manual before using.

■ Ordering information

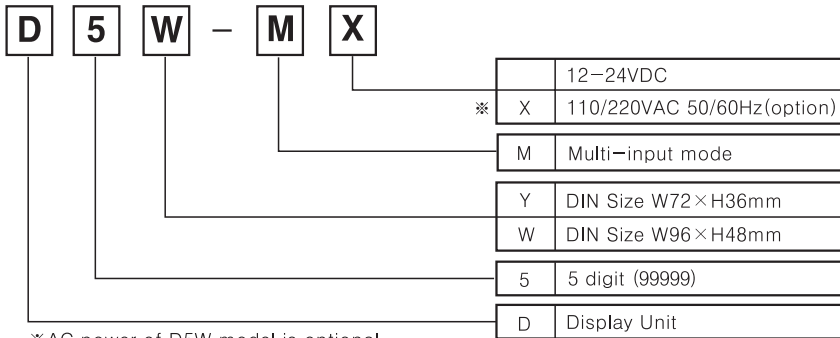

*AC power of D5W model is optional.

■ Specifications

Model	D5Y-M	D5W-M	D5W-MX
Power supply	12-24VDC	12-24VDC	110/220VAC 50/60Hz(option)
Allowable operation voltage	90 ~ 110% of rating voltage		
Power consumption	1.1W		0.8VA
Display method	7Segment LED Display		
Display digit	4digit (or $1\frac{1}{2}$ digit include symbol bit), 5digit		
Max. clock speed	100Hz ~ 5kHz (Except STATIC input type)		
Input logic	Positive logic (PNP), Negative logic (NPN)		
Input mode	BCD Code : STATIC, DYNAMIC, SERIAL (4/5/16/20/25 BIT)		
Zero blanking function	ON ('0' No display), OFF ('0' display)		
Input level	High : 5V-24VDC, Low : 0-2VDC		
Insulation resistance	Min. 100MΩ (at 500VDC)		
Dielectric strength	2000VAC 50/60Hz for 1 minute		
Noise strength	The square wave noise (pulse width: 1μs) by the noise simulator		
Vibration	Mechanical	0.75mm amplitude at frequency of 10 ~ 55Hz in each of X, Y, Z directions for 1 hour	
	Malfunction	0.5mm amplitude at frequency of 10 ~ 55Hz in each of X, Y, Z directions for 10 minutes	
Shock	Mechanical	300m/s ² (Approx. 30G) in X, Y, Z directions for 3 times	
	Malfunction	100m/s ² (Approx. 10G) in X, Y, Z directions for 3 times	
Ambient temperature	-10 ~ 50°C (at non-freezing status)		
Storage temperature	-25 ~ 65°C (at non-freezing status)		
Ambient humidity	35~85%RH		
Weight	Approx. 75g	Approx. 165g	Approx. 267g

Display unit Indication type only

Dimensions

●D5Y-M

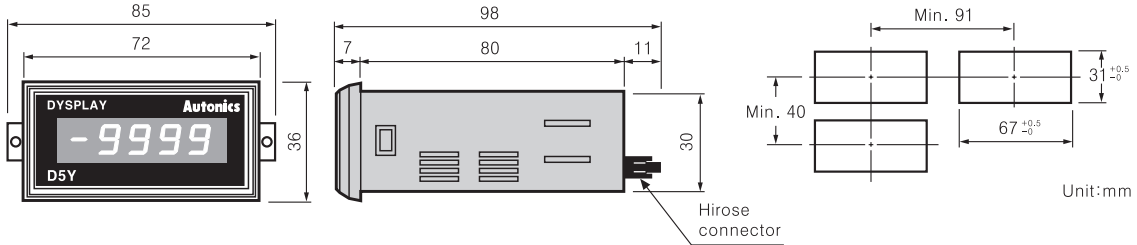

●D5W-M

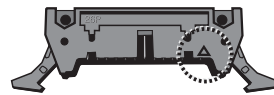
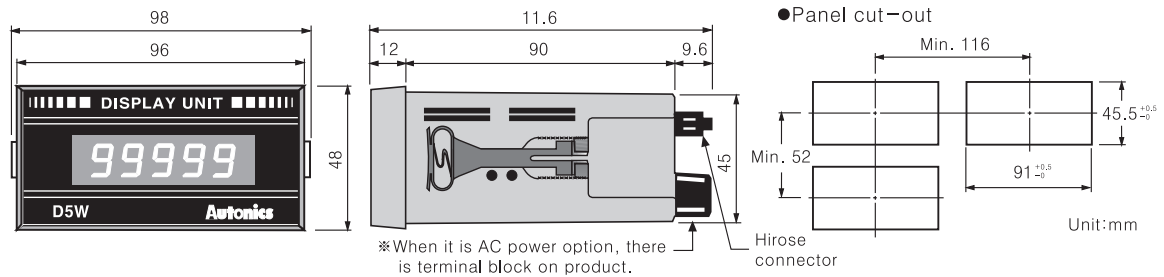

- Hirose Connector Model : HIF3BA-26PA-2.54DS
- The position of triangular signal indicates pin number1 in Hirose connector.

Connections

●STATIC INPUT

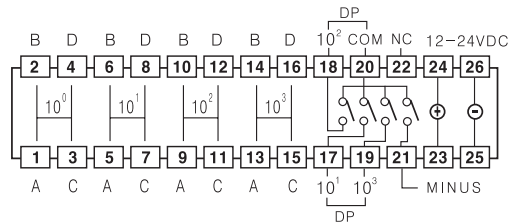

●DYNAMIC INPUT

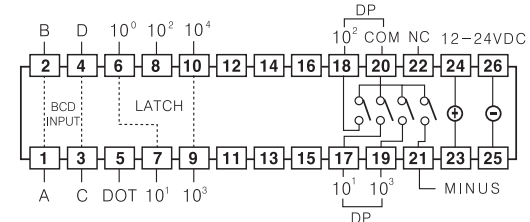

●4/5BIT SERIAL INPUT

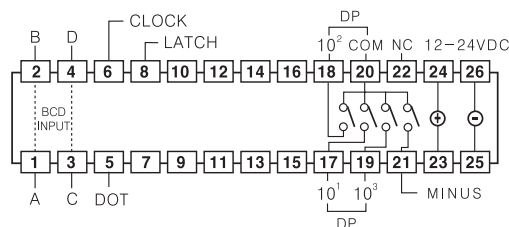

●SERIAL INPUT

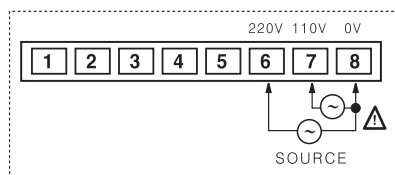
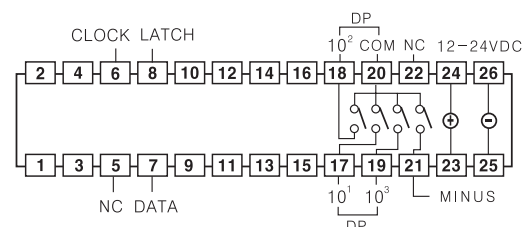

※It is power terminal for AC power option of D5W type.

- ※In case of static input, 5digits cannot be used because of outer terminal.
- ※"-" signal cannot be indicated in 5digits type because the display range is from 0 ~ 99999. Therefore, the input of dot signal on 10⁰ position and Minus terminal (Pin No. 21) is ignored.
- ※The input of outer DP(Pin No. 17, 18, 19) and Minus signal terminal (Pin No. 21) is displayed when connecting COM(Pin No. 20) regardless input logic.

D5Y/D5W SERIES

Input mode and function

Input signal

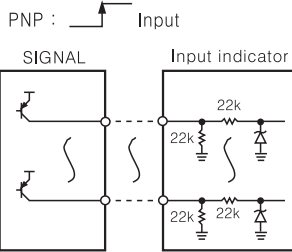

Positive logic

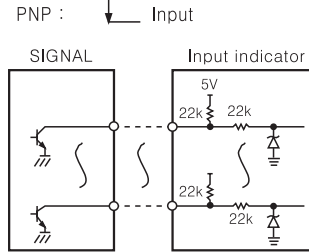

Input timing

Parallel input

Positive (PNP) logic

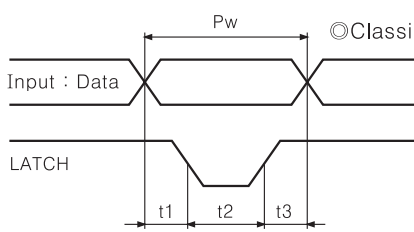

Negative (NPN) logic

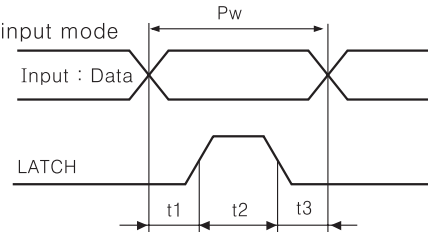

Classification of input mode

$$Pw = t1 + t2 + t3$$

- Pw : 0.2ms [Min.]
- t1 : 0.05ms [Min.] → Data latch (Latch)
- t2 : 0.1ms [Min.] → Data shift
- t3 : 0.05ms [Min.] → Data latch (Latch)

Serial input

Positive (PNP) logic: Clock max. 5kHz

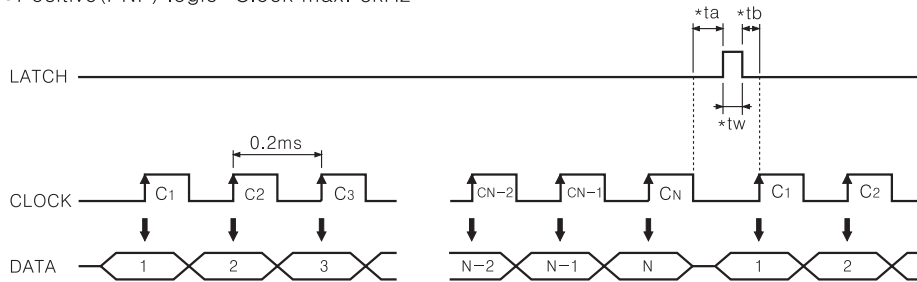

Negative (NPN) input: Clock max. 5kHz

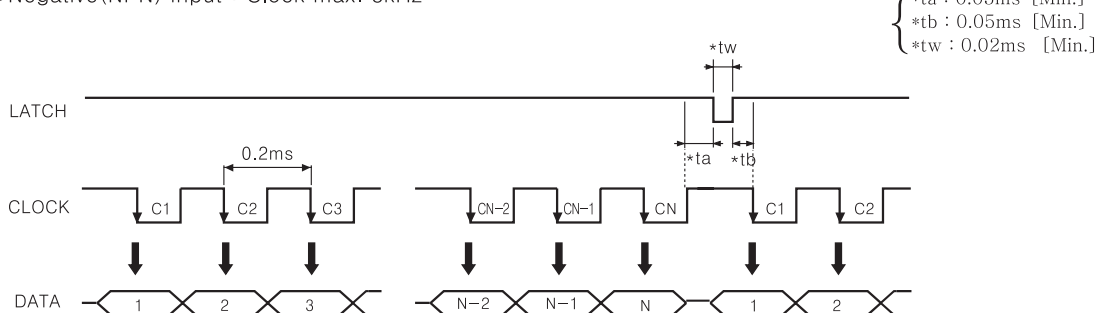

Display unit Indication type only

Input data chart

Display	Positive(PNP) input					Negative(NPN) input				
	A	B	C	D	LATCH	A	B	C	D	LATCH
0	L	L	L	L	H	H	H	H	H	L
1	H	L	L	L	H	L	H	H	H	L
2	L	H	L	L	H	H	L	H	H	L
3	H	H	L	L	H	L	L	H	H	L
4	L	L	H	L	H	H	H	L	H	L
5	H	L	H	L	H	L	H	L	H	L
6	L	H	H	L	H	H	L	L	H	L
7	H	H	H	L	H	L	L	L	H	L
8	L	L	L	H	H	H	H	H	L	L
9	H	L	L	H	H	L	H	H	H	L
HOLD	X	X	X	X	L	X	X	X	X	H

※Input level : Hight → 5-24VDC, Low → 0-2VDC

※"X" : Both Hight or Low level can be input.

D5Y/D5W SERIES

Inner switch

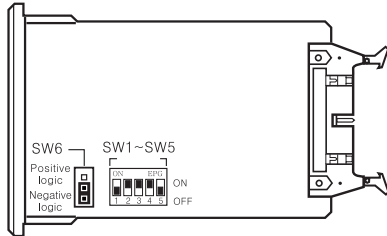

D5Y-M

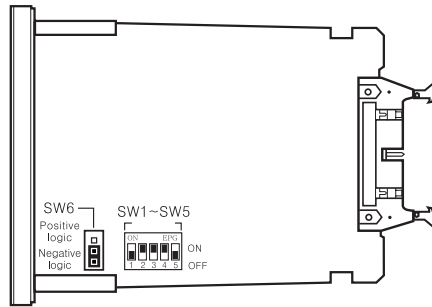

D5W-M

Input mode

ON	SW1	SW2	ON	STATIC input
OFF	SW1	SW2	OFF	
ON	SW1	SW2	ON	DYNAMIC input
OFF	SW1	SW2	OFF	
ON	SW1	SW2	ON	4/5 BIT SERIAL input
OFF	SW1	SW2	OFF	
ON	SW1	SW2	ON	SERIAL input
OFF	SW1	SW2	OFF	

Zero Blank function

SW3	ON	Using Zero Blank function
	OFF	Non-using function

※Zero blanking method ?

: It is to remove "0" indication, which has no meaning.

Ex1)When indication value is "10" in 4 digit LED

- Zero blanking function is applied :
- Zero blanking function is not applied :

Minus signal/DOT(Decimal point) input port

SW4	ON	Using DOT terminal(Pin No. 5)
	OFF	Using outer DP(Pin No. 17, 18, 19, 20) terminal and Minus(Pin No. 21) terminal

Display digit

SW5	ON	5digit (0~99999)
	OFF	4digit (-9999~9999)

※In case of static input, 5digits cannot be used because of outer terminal.

Input logic

SW6	Positive logic	Negative logic	Positive input(PNP input)
	Positive logic	Negative logic	Negative input(NPN input)

※If changing inner selecting switch when power is ON, it does not operate as a changed mode.
If the mode is changed when power is ON, please turn OFF and then turn ON the power.

Latch

SW7	ON	Reverse latch signal to set logic in SW6
	OFF	Correspond latch signal to set logic in SW6

※BCD output and latch signal of low speed serial output, which are optional output of Pulse meter(MP5Y/W series) and multimeter(MT4Y/W series) is outputted to a positive logic (NPN). If connecting D5Y/W, use it after setting SW6 to NPN and soldering(ON) the semi-contact(SW7) of inner PCB solder plate.

How to select decimal point

DOT and symbol input is not serial input [SW4 = OFF]

Terminal 17-20 :

18-20 :

19-20 :

21-20 :

OPEN :

Dot and symbol(-) input is serial input [SW4=ON]

- ①When it is Dynamic mode and 4/5 Bit serial mode, 5 will be input.
- ②When it is serial input mode, 1 bit of serial data is used for Dot and symbol. (See Time chart)

Display unit Indication type only

Time chart(4digit)

Serial input(Serial connection)

20 Bit data(Negative logic)

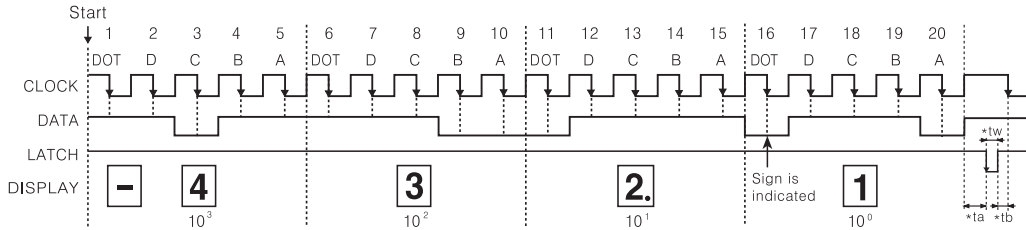

※16th data of 10^0 digit will be indicated "-".

{ *ta : 0.05ms [Min.]
*tw : 0.02ms [Min.]
*tb : 0.03ms [Min.]

16 Bit data(Negative logic)

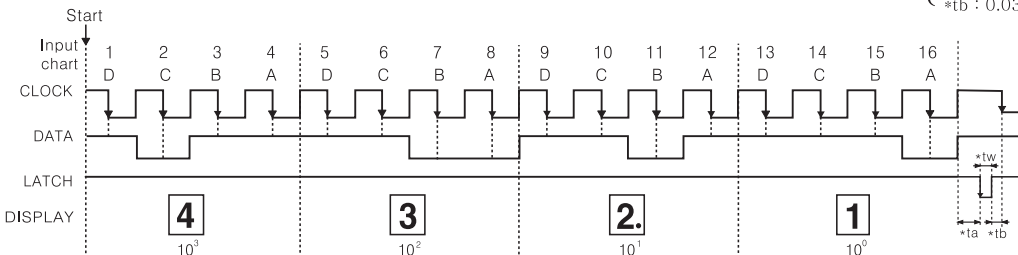

※Data will be fixed when clock is changed from high to low, and latch pulse is changed from high to low.
※Hold time is the next latch pulse is changed from high to low.

4/5 Bit Serial input

4Bit Serial input(Negative logic)

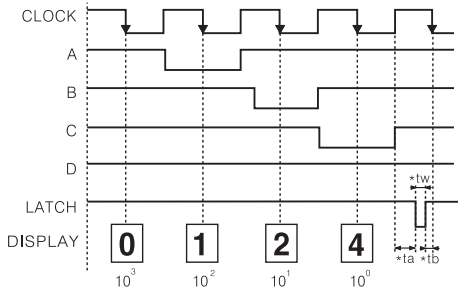

※Concerning decimal point and "-" signal, it can be displayed using outer DP and Minus terminal.
※Above application shows that zero blank function is not used.
If using zero blank function, "0" on 10^3 position will not be displayed.

5BIT Serial input(Negative logic)

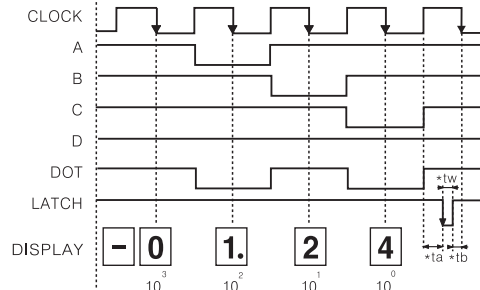

※When dot data is inputted on 10^0 position, it will display "-".

DYNAMIC input

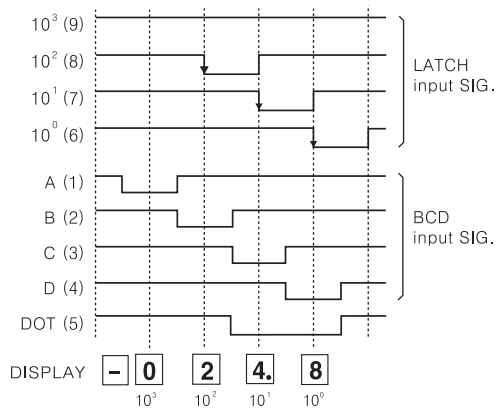

※Left figure shows the waveform of negative logic input.
In case of positive logic, it will be reversed.
※If dot data is inputted on 10^0 position, it displays "-" signal.
※Concerning decimal point and "-" signal, it can be displayed using outer DP and Minus terminal not a serial input.
※Latch input should be later than BCD input, otherwise, it will display the previous data.
※The left application of display indicates non-using zero blank function.
If using zero blank function, the "0" on 10^3 position is not displayed.
※The number in round brackets indicates connector pin number.

D5Y/D5W SERIES

Time chart(4digit)

Serial input(Serial connection)

25 Bit data(Negative logic)

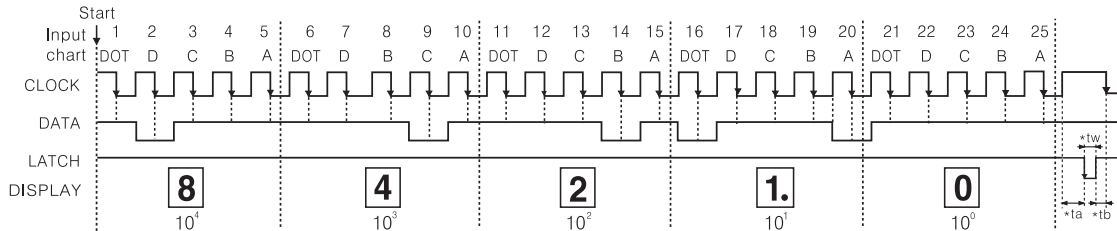

20 Bit data(Negative logic)

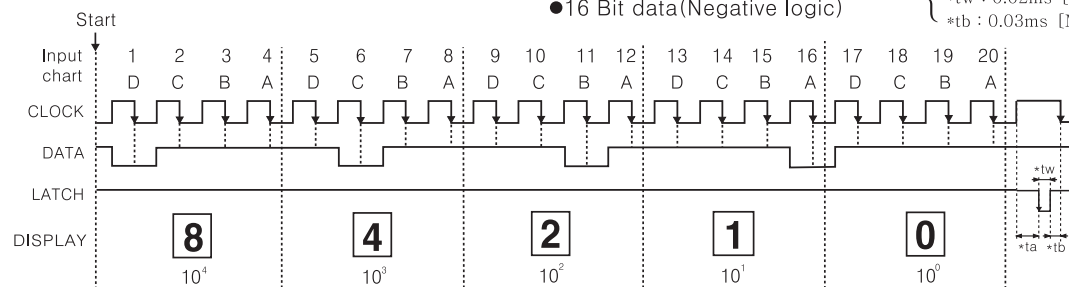

16 Bit data(Negative logic)

- *ta : 0.05ms [Min.]
- *tw : 0.02ms [Min.]
- *tb : 0.03ms [Min.]

- * "-" signal cannot be indicated in 5digit type. [The input of dot signal on 10^0 position and Minus terminal (Pin No. 21) is ignored.]
- * Data will be fixed, when clock is changed from High to Low, and latch will hold input data when latch pulse is changed from High to Low.
- * Hold time is the next latch pulse is changed from High to Low.

4/5 BIT SERIAL input

4Bit Serial input(Negative logic)

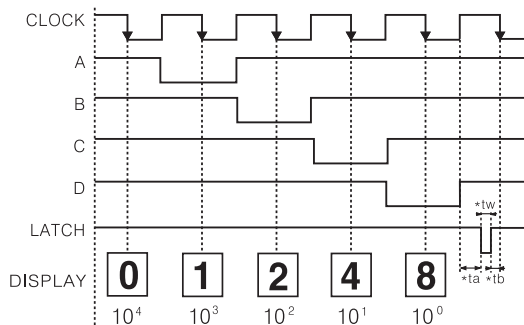

5BIT Serial input(Negative logic)

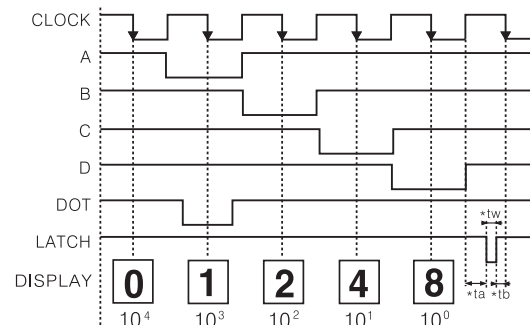

- * In case of 5digits, dot terminal (Pin No. 5) is used only for decimal point. (Minus signal cannot be used.)
- * Above application shows that zero blank function is not used. If using zero blank function, "0" on 10^4 position will not be displayed.

DYNAMIC input

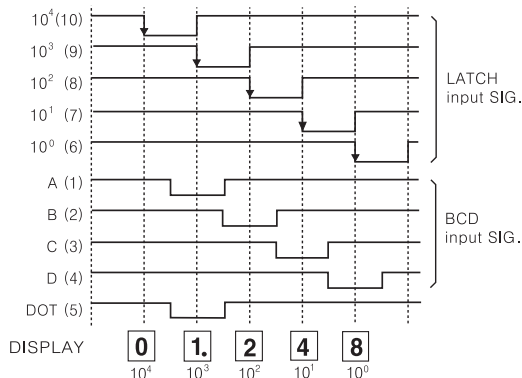

- * Left figure shows the waveform of negative logic input. In case of positive logic, it will be reversed.
- * In case of 5digits, dot terminal (Pin No. 5) is used only for decimal point. (Minus signal cannot be used.)
- * Latch input should be later than BCD input, otherwise, it will display the previous data.
- * The left application of display indicates non-using zero blank function. If using zero blank function, the "0" on 10^4 position is not displayed.
- * The number in round brackets indicates connector pin number.

Display unit Indication type only

■ Proper usage

1. The way of custody

Avoid direct ray of light when keeping long time, and keep it under $-25\sim 65^{\circ}\text{C}$, 35~85% of relative humidity.

2. Noise

Concerning the product (D5W-MX type) using AC power, inflow of noise through a power line is a major problem. The 1st stage of power trans has a condenser preventing noise, but it is hard to make a perfect circuit built in small product.

Therefore, use an absorbing circuit such as outer line filter and varistor when abnormal voltage is occurred in the same line by power relay, magnet S/W, using a high-frequency machine, high voltage of spark or lightning stroke.

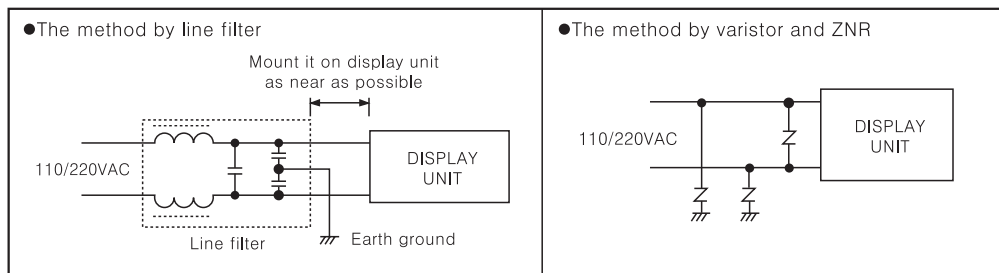

3. Input signal line should be short as much as possible.

If the line is too long, it will affect noise.

4. If the time of input signal is overlapped, it may occur faint light.

5. Oil, soot or dust must not be flown into the product.

6. A decimal point and "-" signal can be displayed with outer DP terminal and Minus terminal when signal level is "High". (High level : 5V~24VDC)

7. Because Hirose connector has both power line (12~24VDC) and DATA signal line, please connect the lines after checking connection figure.